

LADDER-STYLE BOOKSHELF

CONSTRUCTION PLAN



Difficulty level: **T** | EASY

Completion time: **4 hours**

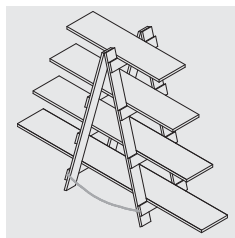
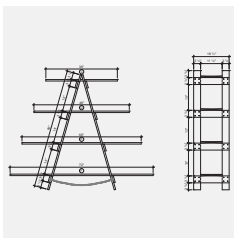

LADDER-STYLE BOOKSHELF

Easy to build, move and store, this folding bookshelf is a quick and easy way to create additional display space when and where you want it.

The bookshelf is made of two vertical supports connected by a hinge to form a "ladder." The shelves are then laid across the ladder "rungs." A chain prevents the two supports from spreading out too far from one another.

This ladder-style bookshelf, which requires no particular skill or specialized tools to build, measures 72" wide at its base and about 60" high. The shelves are simply laid across the rungs of a ladder structure, which can be folded for easy storage.

The pine boards can be stained to match your decor and varnished to enhance the look and for easier cleaning. If you plan to stain or varnish the bookshelf, or even leave it in its natural state, you can fill the screw holes with wood buttons. In this case, since the buttons will be visible, take care to position screws evenly and precisely, and not randomly. Also, before screwing, pre-drill to a depth of 1/4" with a 3/8" drill bit to allow for the insertion of the buttons.

If you plan to paint the bookshelf, there is no need to pre-drill; you can simply patch the holes with filler.



TOOLS AND MATERIALS NEEDED

TOOLS

- > Circular saw or sliding mitre saw
- > Drill-screwdriver
- > Drill bit, 3/8" with depth stop
- > Measuring tape
- > Square
- > Pencil

MATERIALS

- > 5 pine boards, 1" x 4" x 96"
- > 3 pine boards, 1" x 11 1/4" x 96"
- > 1 1/2" No. 6 screws
- > Small chain 65"
- > Piano hinges or other
- > Filler or wood buttons with 3/8" head

BEFORE ASSEMBLY

CUTTING LIST

Sand the cut parts to smooth the edges, if necessary.

Before assembling, mark each part clearly with the corresponding letter, and apply finishing products (stains, varnishes) if desired.

Boards, 1" x 4" x 96"

PIECES	QUANTITY	WIDTH (")	LENGTH (")
A UPRIGHT	4	3 1/2	60
B RUNG	8	3 1/2	17 7/8

Boards, 1" x 11 1/4" x 96"

PIECES	QUANTITY	WIDTH (")	LENGTH (")
B SHELF 1	1	11 1/4	36
C SHELF 2	1	11 1/4	48
D SHELF 3	1	11 1/4	60
E SHELF 4	1	11 1/4	72

LADDER-STYLE BOOKSHELF

BEFORE ASSEMBLY (CONT'D)

ELEVATIONS

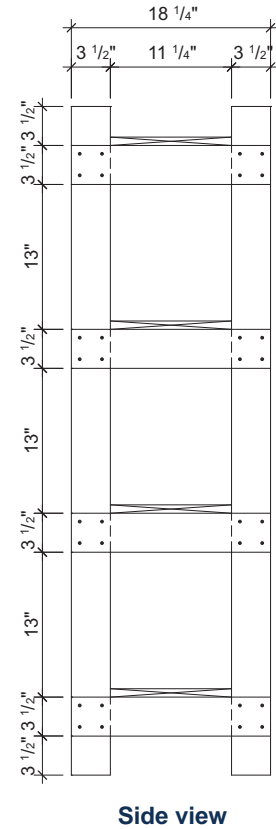
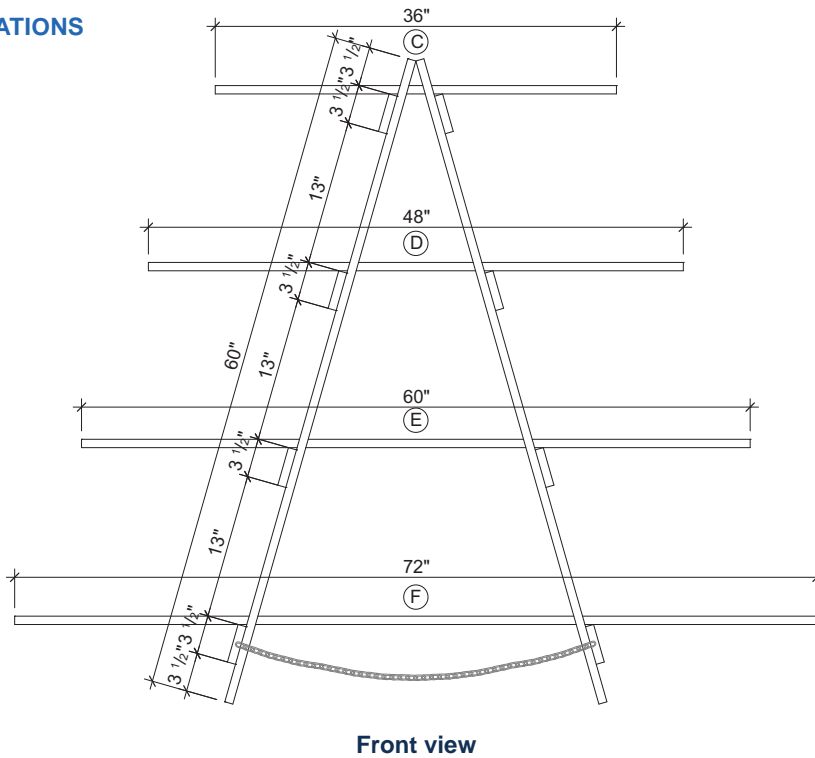

ASSEMBLY

- 1 Start assembling the first side of the "ladder" by screwing a B rung to the A uprights, 3 1/2" from their ends, using 4 screws on each side, as illustrated.
- 2 Screw the other B rungs at 13" intervals. All B parts should be flush with the outside edges of the A uprights.
- 3 Repeat steps 1 and 2 to build the second side of the "ladder".
- 4 Fill the holes.

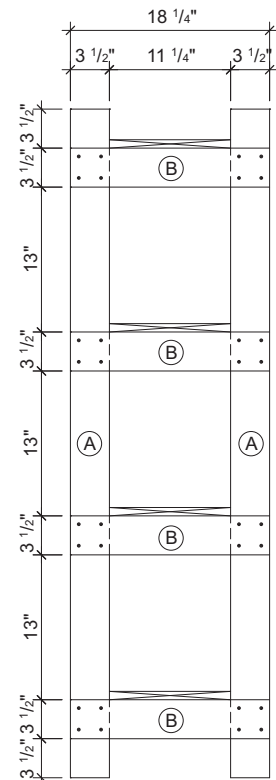

LADDER-STYLE BOOKSHELF

ASSEMBLY (CONT'D)

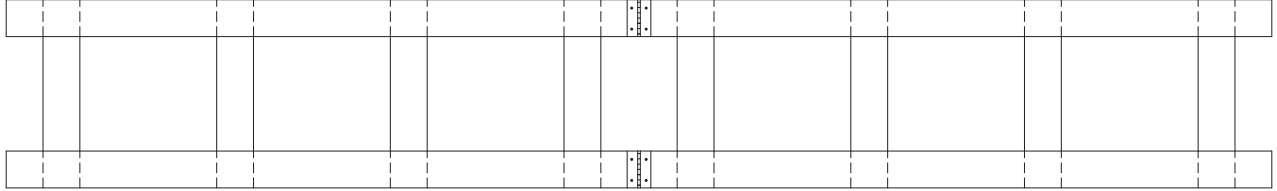

- 5 Connect the two upper ends of the two vertical supports with piano hinges attached to the underside.
- 6 Screw the ends of the chain 5 1/4" from the bottom of each side of the "ladder" on the outside edge.
- 7 Slide the shelves onto the rungs.

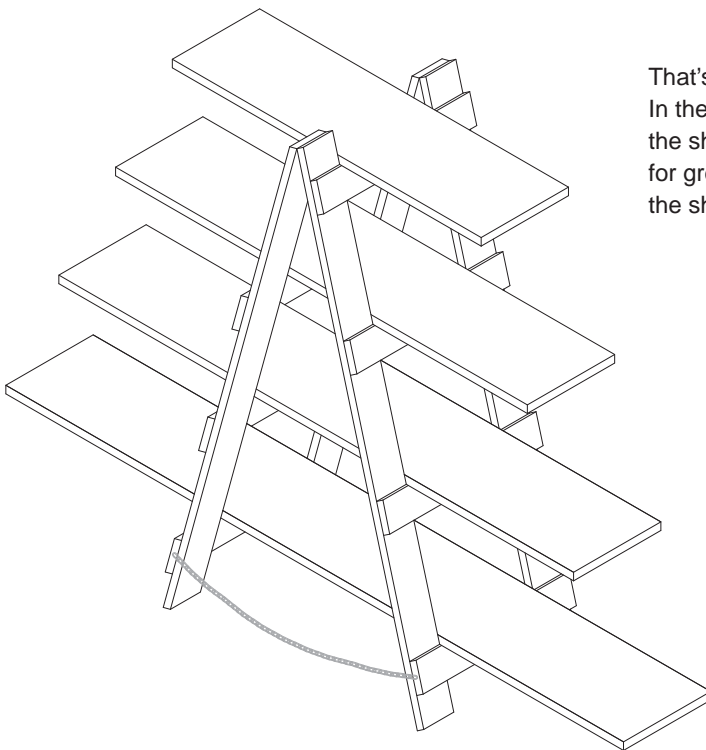

That's it—your bookshelf is finished!
In theory, to retain its "mobile" and "easy to store" features, the shelves should only be slid into place. However, for greater stability, we suggest you screw the shelves to the rungs they rest on.